



Yuasa Technical Data Sheet

Yuasa YTX16-BS - Maintenance Free Battery

Performance

Voltage	12V
Capacity (10-hour)	14Ah
Capacity (20-hour)	14.7Ah
CCA @ -18°C	230A

Dimensions (±2mm)

Length	150mm
Width	87mm
Height	161mm

Weights & Measures

Mean Weight with Acid	5.3kg
Acid Volume	0.78l

Mounting Angle

Angle A	30°
Angle B	20°
Angle C	20°

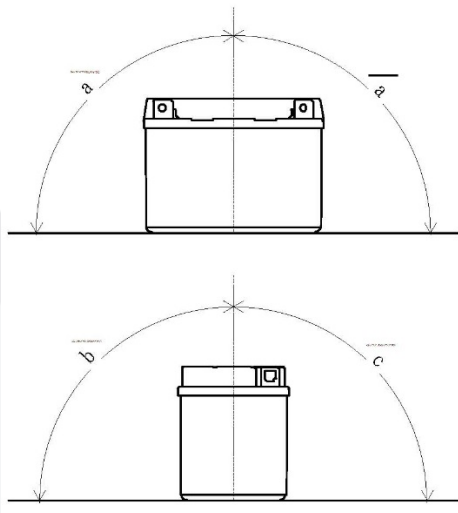

Technology

Separator AGM

Cell Assembly Layout

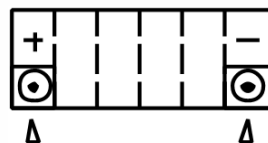

Terminal Type - 4



Data Sheet generated on 12/12/2016 - E&OE