



Yuasa Technical Data Sheet

Yuasa YTX12-BS - Maintenance Free Battery

Performance

Voltage	12V
Capacity (10-hour)	10Ah
Capacity (20-hour)	10.5Ah
CCA @ -18°C	180A

Dimensions (±2mm)

Length	150mm
Width	87mm
Height	130mm

Weights & Measures

Mean Weight with Acid	4.2kg
Acid Volume	0.6l

Mounting Angle

Angle A	30°
Angle B	20°
Angle C	20°

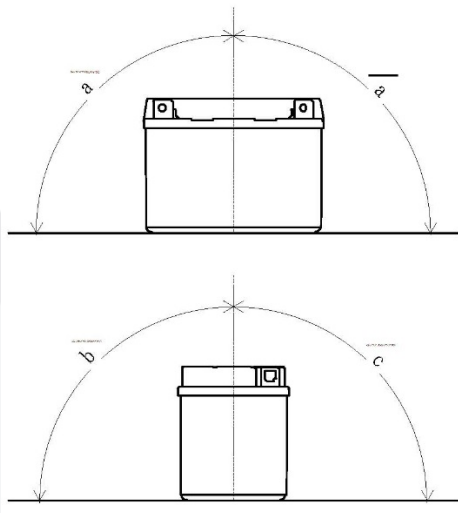

Technology

Separator AGM

Cell Assembly Layout

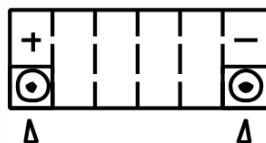

Terminal Type - 5



Data Sheet generated on 12/12/2016 - E&OE