



Yuasa Technical Data Sheet

Yuasa YB9L-A2 - YuMicron Battery

Performance

Voltage	12V
Capacity (10-hour)	9Ah
Capacity (20-hour)	9.5Ah
CCA @ -18°C	100A

Dimensions (±2mm)

Length	135mm
Width	75mm
Height	139mm

Weights & Measures

Mean Weight with Acid	3.1kg
Acid Volume	0.6l

Mounting Angle

Angle A	Vertical only
Angle B	Vertical only
Angle C	Vertical only

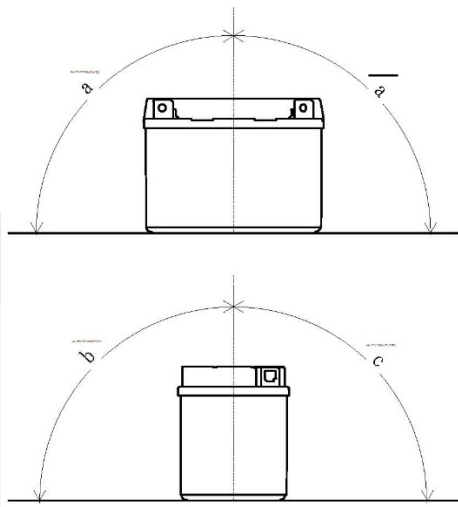

Cell Assembly Layout

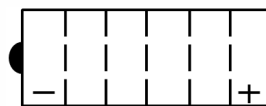

Terminal Type - 2



Data Sheet generated on 12/12/2016 - E&OE