



## Yuasa Technical Data Sheet

### Yuasa YTX4L-BS - Maintenance Free Battery

#### Performance

Voltage	12V
Capacity (10-hour)	3Ah
Capacity (20-hour)	3.2Ah
CCA @ -18°C	50A

#### Dimensions (±2mm)

Length	114mm
Width	71mm
Height	86mm

#### Weights & Measures

Mean Weight with Acid	1.4kg
Acid Volume	0.18l

#### Mounting Angle

Angle A	30°
Angle B	20°
Angle C	20°

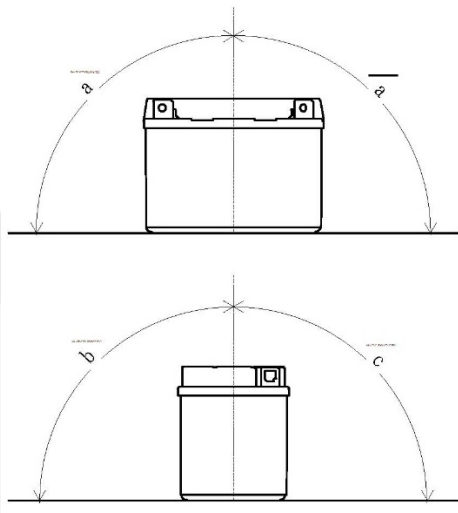

#### Technology

Separator AGM

#### Cell Assembly Layout



#### Terminal Type - 5



Data Sheet generated on 12/12/2016 - E&OE