

# EVX 12520

## 12V 52Ah

EVX 12520 is designed specially for electric vehicles, such as electric golf cart, electric wheelchair, mower, dust collector...etc. It has high cycling life, high efficiency and long service life.



### Specification

<b>Cells Per Unit</b>	6
<b>Voltage Per Unit</b>	12
<b>Capacity</b>	52Ah @ 20hr-rate to 1.75V per cell @25 °C (77°F)
<b>Weight</b>	Approx. 18.3 kg(40.35 lbs)
<b>Maximum Discharge Current</b>	500A(5sec)
<b>Internal Resistance</b>	Approx. 5.5 mΩ
<b>Operating Temperature Range</b>	Discharge: -15°C~50°C ( 5°F~122°F) Charge: -15 °C~40°C ( 5°F~104°F) Storage: -15°C~40°C ( 5°F~104°F)
<b>Nominal Operating Temperature Range</b>	25°C±3°C(77°F±5°F)
<b>Float Charging Voltage</b>	13.5 to 13.8 VDC/unit Average at 25 °C(77°F)
<b>Recommended Maximum Charging</b>	15.6A
<b>Current Limit</b>	
<b>Equalization and Cycle Service</b>	14.4 to 15.0 VDC/unit Average at 25 °C(77°F)
<b>Self Discharge</b>	CSB Batteries can be stored for more than 6 months at 25°C(77°F). Please charge batteries before using. For higher temperatures the time interval will be shorter.
<b>Terminal</b>	B4-L terminal to accept M6 nut & bolt
<b>Container Material</b>	Polypropylene(UL 94-V0/File E50955)*Flammability resistance of (UL 94-HB/File E216959) can be available upon request.



CSB-manufactured batteries are UL-recognized components under UL924 and UL1989. CSB is also certified by ISO 9001 and ISO 14001.

### Dimensions

unit: (MM)

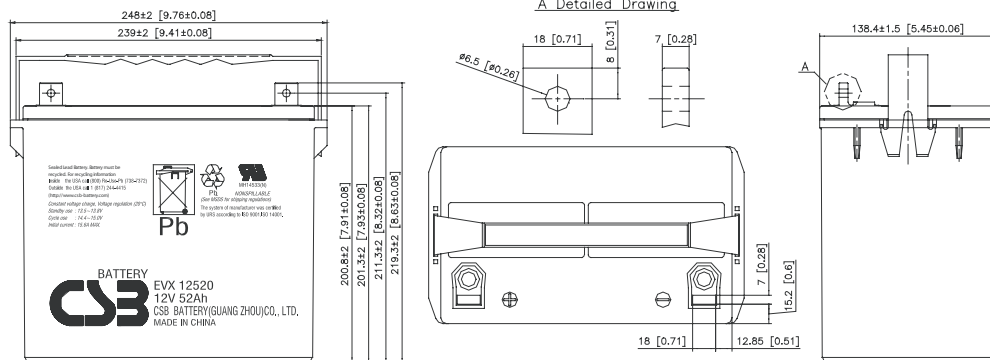

### Constant Current Discharge Characteristics Unit:A (25°C, 77°F)

F.V/Time	30MIN	60MIN	90MIN	2HR	3HR	4HR	5HR	8HR	10HR	20HR
1.60V	64.90	36.80	28.90	21.00	14.60	11.70	9.45	6.60	5.42	2.84
1.67V	63.50	36.20	28.50	20.80	14.40	11.60	9.41	6.55	5.37	2.81
1.70V	62.00	35.70	28.15	20.60	14.30	11.50	9.40	6.52	5.35	2.80
1.75V	60.60	35.20	27.75	20.30	14.20	11.40	9.34	6.47	5.31	2.78
1.80V	59.20	34.70	27.40	20.10	14.00	11.30	9.31	6.24	5.12	2.75
1.85V	57.80	34.20	27.05	19.90	13.90	11.20	9.17	6.11	5.03	2.62

### Constant Power Discharge Characteristics Unit:W (25°C, 77°F)

F.V/Time	30MIN	60MIN	90MIN	2HR	3HR	4HR	5HR	8HR	10HR	20HR
1.60V	668.00	386.00	303.50	221.00	154.00	124.00	101.00	70.90	58.70	33.60
1.67V	661.00	380.00	299.50	219.00	153.00	123.00	102.00	70.60	58.00	33.30
1.70V	653.00	376.00	296.50	217.00	152.00	123.00	102.00	70.60	58.00	33.20
1.75V	634.00	372.00	293.00	214.00	151.00	122.00	101.00	70.10	57.70	32.60
1.80V	615.00	368.00	290.00	212.00	151.00	121.00	101.00	67.60	55.80	31.90
1.85V	598.00	363.00	286.00	209.00	150.00	119.00	99.00	66.10	54.80	30.40

- All mentioned values are average values.
- Tolerance: X<6min(+15%~-15%), 6min ≤ X<10min(+12%~-12%), 10min ≤ X<60min(+8%~-8%), X ≥ 60min(+5%~-5%)

### Trickle (or Float) Service Life

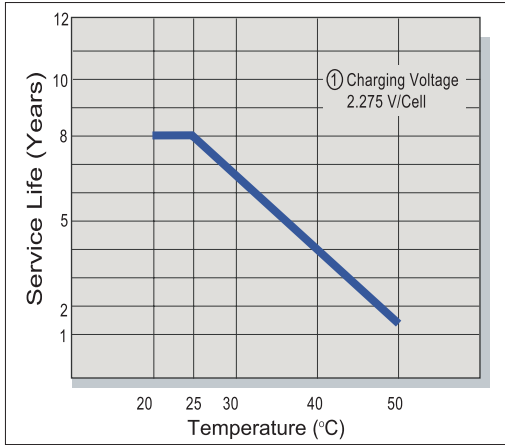

### Capacity Retention Characteristic

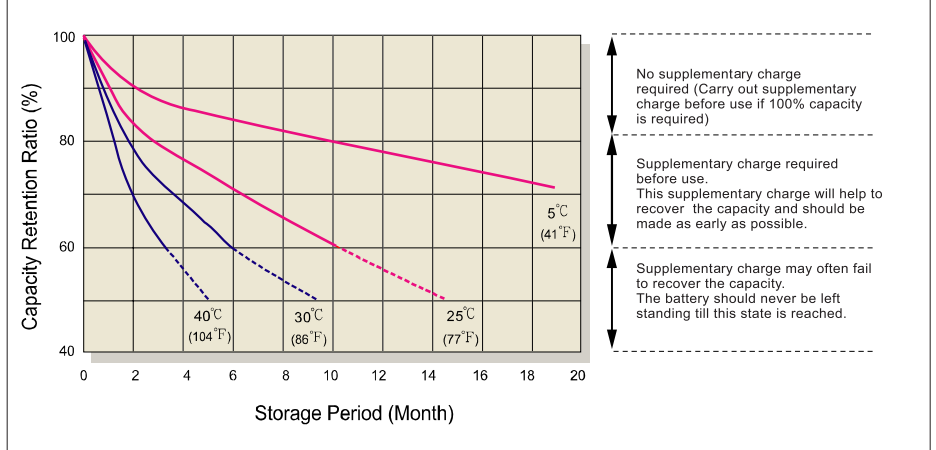

### Battery Voltage and Charge Time for Standby Use

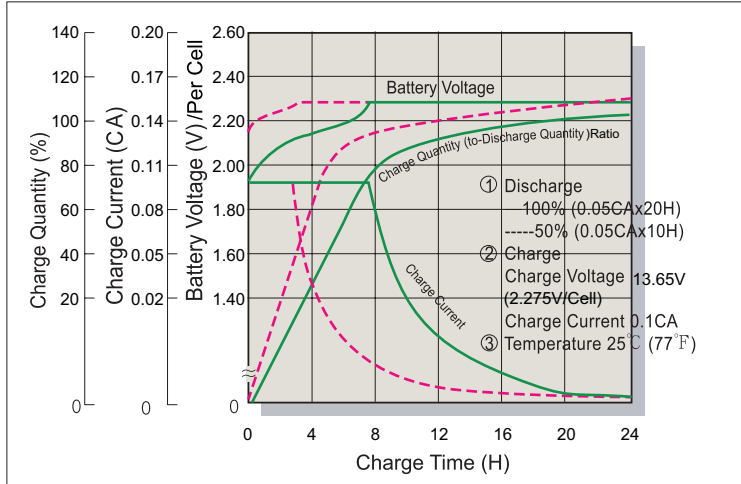

### Series Cycle Service Life

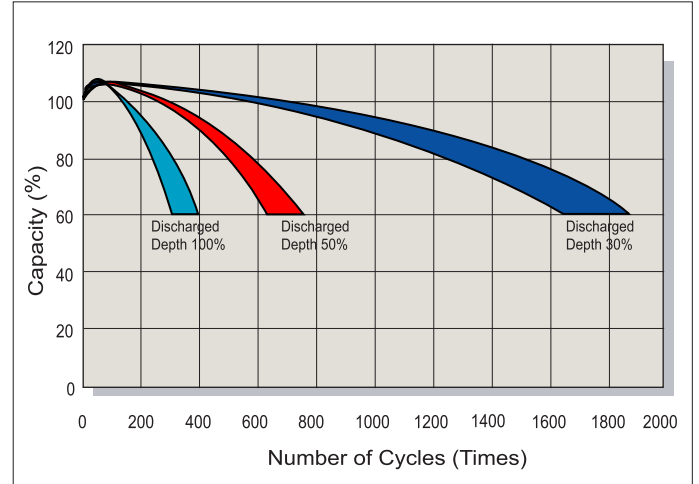

### Battery Voltage and Charge Time for Cycle Use

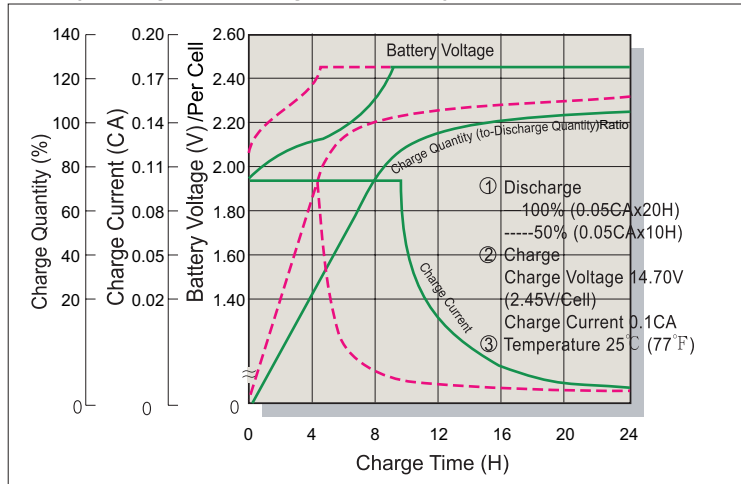

### Terminal Voltage (V) and Discharge Time

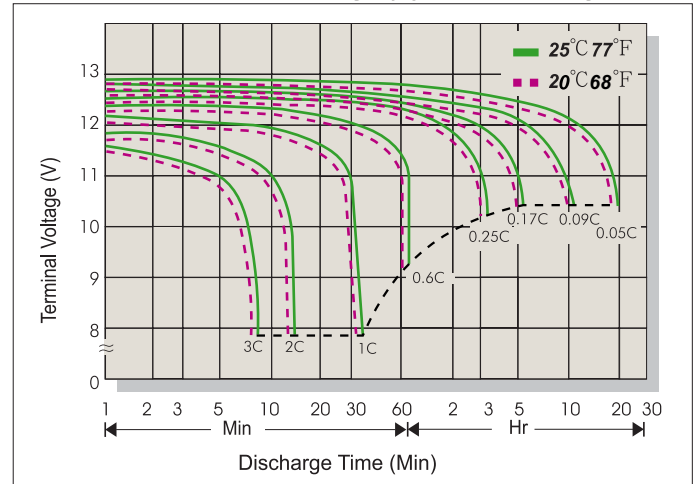

### Charging Procedures

Application	Charge Voltage(V/Cell)			Max.Charge Current
	Temperature	Set Point	Allowable Range	
Cycle Use	25°C(77°F)	2.45	2.40~2.50	0.3C
Standby	25°C(77°F)	2.275	2.25~2.30	

### Discharge Current VS. Discharge Voltage

Final Discharge Voltage V/Cell	1.75	1.70	1.60	1.30
Discharge Current(A)	0.2C>(A)	0.2C<(A)<0.5C	0.5C<(A)<1.0C	(A)>1.0C

Sales Office URL: [WWW.CSB-BATTERY.COM](http://WWW.CSB-BATTERY.COM)

**CSB BATTERY CO., LTD.**  
TAIWAN OFFICE  
Tel: +886-2-2555-5600  
Fax: +886-2-2555-3300  
E-mail: [service@csb-battery.com.tw](mailto:service@csb-battery.com.tw)

**CSB BATTERY TECHNOLOGIES (BEIJING) CO., LTD.**  
BEIJING OFFICE  
Tel: +86-10-59621300/59621301/59621302/59621303  
Fax: +86-10-59621304  
mail: [chinasls@csb-battery.com](mailto:chinasls@csb-battery.com)

**CSB BATTERY TECHNOLOGIES, INC**  
USA OFFICE  
Tel: +1-817-244-7777/1-8003 CSBUSA(272872)  
Fax: +1-817-244-4445  
E-mail: [csb@csb-battery.com](mailto:csb@csb-battery.com)

**CSB BATTERY LOGISTICS (SHANGHAI) CO., LTD.**  
SHANGHAI OFFICE  
Tel: +86-21-5046-1622, 5046-0833  
Fax: +86-21-5064-3314  
E-mail: [chinasls@csb-battery.com](mailto:chinasls@csb-battery.com)

**CSB BATTERY OF NETHERLANDS B.V**  
NETHERLANDS OFFICE  
Tel: +31(0) 180 418 140  
Fax: +31(0) 180 418 327  
E-mail: [eurossales@csb-battery.com](mailto:eurossales@csb-battery.com)

**CSB BATTERY LOGISTIC (SHANGHAI) CO., LTD.**  
SHENZHEN OFFICE  
Tel: +86-755-8831-6488/6396/16356  
Fax: +86-755-8831-6548  
mail: [she@csb-battery.com.cn](mailto:she@csb-battery.com.cn)